

THE XXVII EDITION
THE XXVII EDITION
INTERNATIONAL EXHIBITION MUESTRA INTERNACIONAL

noken
PORCELANOSA BATHROOMS



Hello!!
Hola!!

INDEX —

MANIFESTO	4
WATERFOREST	6
MADISON	8
LIEM	14
FINISH STUDIO	26
OXO	32
SQUARE vs ROUND	42
NK CERAMICS COLORS	52
LIGNAGE	56
TOUCH & FEEL	62
UNDER WATER	66
PRESS TO COLOR	72
SMART TOILET	76
LOUNGE	80

MANI — — FESTO



Water...

Water that flows, caressing softly and hitting with strength.

Clear and clean water, which is alive, and which gives life.

Water...

Which simmers subtly and evasively. What air is. What essence is.

which is elevated to create magic shapes that touch the sky.

Water...

Solid, magnificent, white and pure. Mysterious and silent.

Creator of landscapes and capable of bringing time to a halt.

These are the three states of water.

This is what people say who do not see beyond it.

Because there is more.

Another state of water exists which very few can see...

Agua...

Agua que fluye, que acaricia con suavidad y que golpea con fuerza.

Agua transparente y limpia, que vive, que da vida.

Agua...

Que bulle sutil y esquiva. Que es aire. Que es esencia.

Que se eleva para crear formas mágicas al tocar el cielo.

Agua...

Firme, imponente, blanca y pura. Misteriosa y silenciosa.

Creadora de paisajes y capaz de detener el tiempo.

Son los tres estados del agua.

Eso dicen quienes no ven más allá.

Porque hay más.

Existe otro estado del agua que muy pocos pueden ver...

Some people are able to sculpt with it, creating almost impossible shapes in the blink of an eye which is unfathomable.

Some people are inspired by its most ethereal state, turning it into a painting, into art, into a dream.

Some people experiment and play around with it in order to capture its very own cold beauty in perfect patterns and designs.

And furthermore, there are people who are able to create feelings, emotions and spaces with it.

Caressing the skin, awakening our senses, making our own imagination fly high with its beauty.

A state which is above and beyond the rest...

A state which, at last, many can reach.

NOKEN. Water in an inspirational state.

Hay quien es capaz de esculpir con ella, creando formas imposibles en un segundo tan efímero como infinito.

Hay quien se inspira en su estado más etéreo convirtiéndola en lienzo, en arte, en ilusión.

Hay quien experimenta y juega con ella para plasmar su fría belleza en perfectos patrones y diseños.

Y también hay quien es capaz de crear sensaciones, emociones y espacios con ella. Acariciando la piel, despertando nuestros sentidos y haciendo volar nuestra imaginación con su belleza.

Es el cuarto estado del agua.

Un estado superior a todos los demás...

Un estado que, por fin, muchos pueden alcanzar.

NOKEN. Agua en estado de inspiración.



WATERFOREST

In recent years, the bathroom has ceased from being an essentially practical space to becoming the main room for our emotional wellness. New solutions in equipment encourage us to rediscover a new revitalised space, designed so that we take care of ourselves and optimise the time we spend in there. A unique, personal and responsible space. 73% of household water is used in the bathroom. Therefore, from Noken we offer a new and increasingly responsible and sustainable use of this room.

If this is your lifestyle, we also design for you.

En los últimos años, el baño ha dejado de ser un espacio esencialmente práctico para convertirse en una estancia protagonista para nuestro bienestar emocional. Nuevas soluciones en equipamiento nos invitan redescubrir un nuevo espacio revitalizado, diseñado para cuidar de nosotros mismos y optimizar mejor el tiempo que pasamos en él.

Un espacio que se eleva como único, personal y responsable.

El 73% del agua del hogar se consume en el baño. Por ello, desde Noken proponemos un nuevo uso cada vez más responsable y sostenible de esta estancia.

Si este es tu estilo de vida, nosotros también diseñamos para ti.



MAD — ISON

Tono wall mounted basin mixer
Madison vanity
Liem countertop basin

Monomando encastre lavabo Tono
Mobiliario Madison
Lavabo Liem

Modular harmony

From the modular concept to a rhythmic composition

Armonía modular

Del concepto modular a la composición rítmica

With a textured front and a taupe colour, Madison banks on a push opening system and a soft-close system. The inside of the drawer comes in a textured finish which simulates leather in a grey finish, and the worktop is done with a 10mm thickness tempered transparent glass, which is in keeping with the tone of the furniture. It is combinable with Slender basins in both the square and round formats.

Con frontal en textura y color taupé, Madison cuenta con sistema de apertura tipo push y cierre ralentizado. El interior del cajón presenta un acabado texturizado que simula la piel en acabado gris, y la encimera está realizada en vidrio matizado templado de 10mm de grosor a tono con el mueble.

Combinable con los lavabos Slender en formato cuadrado y redondo.



Tono wall mounted basin mixer
Madison vanity
Liem countertop basin
Madison mirror

Mobiliario Madison
Monomando encastre lavabo Tono
Lavabo Liem
Espejo Madison

Madison, the new bathroom furniture, comes with a set of modular elements which can be combined in different combinations. An 80cm wall hung unit, a 40cm metallic structure for towels, a shower Caddy to finish the cornering furniture and 40cm floating glass shelving which all make up the bathroom furniture which offers a huge number of possibilities regarding its shapes. As if it were a musical piece, each element portrays both tidiness and rhythm. Its combinatorial capacity is clarified in live harmonic pieces that balance both the shape and the function, which can create a set both flexible and in reach though the imagination.

El nuevo mueble de baño Madison presenta un conjunto de elementos modulares que pueden conjugarse en diferentes combinaciones. Módulo suspendido de 80cm, estructura metálica para toallas de 40cm, un suplemento esquinero para acabar el mueble en curva y una estantería de vidrio de 40cm, componen un mueble de baño capaz de multiplicarse en cuanto a sus formas. Como si de una pieza musical se tratase, cada elemento interpreta el orden y el ritmo. Su capacidad combinatoria se resuelve en unidades armónicas vivas que equilibran forma y función, pudiendo llegar a crearse un conjunto tan flexible como alcance la imaginación.

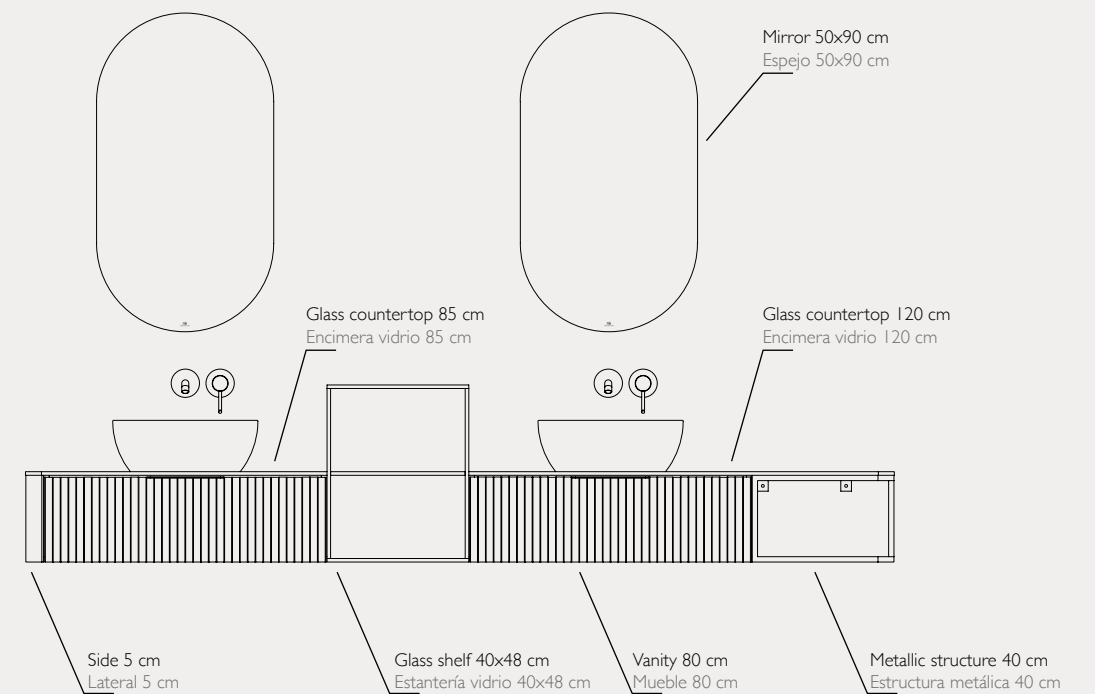



LIEM —

Liem bathtub
Lignage floor mounted bath shower mixer
Liem 120 cm vanity
Liem mirror
Liem countertop basin
Lignage wall mounted basin mixer

Bañera Liem
Grifería de bañera a pavimento Liem
Mobiliario 120 cm Liem
Espejo Liem
Lavabo Liem
Grifería encastre lavabo Lignage



NEW VINTAGE

Vintage style is reborn to reinvent itself

Liem offers a new style for interior design. Calming tones, smooth shapes and contrasts in harmony. The perfect balance between the delightful vintage and contemporary design which blurs out time limits.



NEW VINTAGE

El estilo vintage renace para reinventarse

Liem propone un nuevo lenguaje para el interiorismo. Tonalidades calmadas, formas suaves, y contrastes en armonía. El equilibrio perfecto entre el encanto vintage y el diseño contemporáneo que desdibuja los límites temporales.



Relax. Refresh. Reconnect.

The bathroom that cuddle.

Relax. Renacer. Reconectar.

El baño que abraza.

Liem bathtub
Lignage floor mounted bath shower mixer

Bañera Liem
Grifería de bañera a pavimento Lignage

Thinking up an integral bath

The new Liem bathtub has been designed by following the functional principles of ergonomics. A bath which allows for the spine to rest more comfortably.

With calm curved shapes, a pure aesthetic with a jointless interior has been sought after; thanks to its hidden overflow. It includes a ledge for putting everyday items on, and also for installing the Project Line tap.

Lignage, the signature taps designed by Ramón Esteve.

Best Design at the IF Design Awards 2019.

Lignage is Noken's legacy for future design. A pure-lined design with a classic-renewed essence which reminds us of classic taps but with a modern-day look.

Concibiendo el baño integral

La nueva bañera Liem se ha diseñado siguiendo principios funcionales de ergonomía. Un baño placentero que permite reposar más cómodamente la columna vertebral.

De formas curvas sosegadas, se ha perseguido una estética pura con un interior contínuo gracias a su rebosadero oculto. Incluye una repisa para apoyar objetos de uso diario e instalar la grifería Project Line.

Lignage, la grifería de autor creada por Ramón Esteve.

Mejor Diseño de los IF Design Awards 2019.

Lignage es el legado de Noken al diseño del mañana. Un diseño de líneas depuradas y esencia clásico-renovada recuerda a las griferías clásicas pero con una estética totalmente actual.

Arquitect Rimless C/C adjustable outlet pan
Arquitect bidet
Lignage single lever bidet mixer

Inodoro Arquitect Rimless
Bidé Arquitect
Monomando bidé Lignage



The Liem series comes with an extra 80cm compact size in its furniture range. The same as the 120cm wide furniture, it will be available in two versions: wall hung and floor standing; as well as in two finishes, which are grey matt and sand matt.

We are dealing with a unique piece in which every detail in American walnut natural wood is combined with a countertop manufactured with XTONE, with technical features which make it highly resistant, in the Liem Grey Nature finish for the grey matt version, and in the Ars Beige Nature finish for the furniture in sand matt.

La serie Liem añade una medida compacta de 80 cm a su gama de mobiliario. Al igual que el mueble de 120 cm de ancho, estará disponible en dos versiones: suspendido y con patas al suelo, y en dos acabados, gris mate y arena mate.

Una pieza única en la que se combinan detalles en madera natural de nogal americano junto con una encimera fabricada en XTONE, con propiedades técnicas que lo hacen altamente resistente, en acabado Liem Grey Nature para la versión gris mate, y en acabado Ars Beige Nature para el mueble en arena mate.

The Liem furniture can be combined with the Slender basin in both the round and square formats for the 80cm version, and with regard to the 120cm version, it can be combined with the Liem basin in a rectangular format.

El mueble Liem se podrá combinar con el lavabo Slender en formatos redondo y cuadrado para la versión de 80 cm, y con el lavabo Liem en formato rectangular para la versión de 120 cm.

Liem cabinet
Lignage shower composition
Bottega Caliza shower tray
Liem 120 cm vanity
Liem countertop basin
Lignage wall mounted basin mixer
Liem mirror
Arquitect Rimless C/C adjustable outlet pan

Cabinet Liem
Composición ducha Lignage
Plato ducha
Mobiliario Liem 120 cm
Lavabo Liem
Batería de lavabo encastre Lignage
Espejo Liem
Inodoro Arquitect Rimless



New pieces complement the Liem series with auxiliary pieces of furniture that provide extra storage space.

Nuevos elementos complementan la serie Liem con muebles auxiliares que aportan espacio de almacenamiento extra.



22



23

The new wall-hung cabinet consists of three shelves and a hinged door at 90°. It is available in the same grey and sand furniture finishes, combined with walnut wood.

El nuevo cabinet suspendido se compone de tres baldas y una puerta abatible de apertura en 90°. Disponible en los mismos acabados del mueble -gris y arena, combinados con madera de nogal-.

LIEM

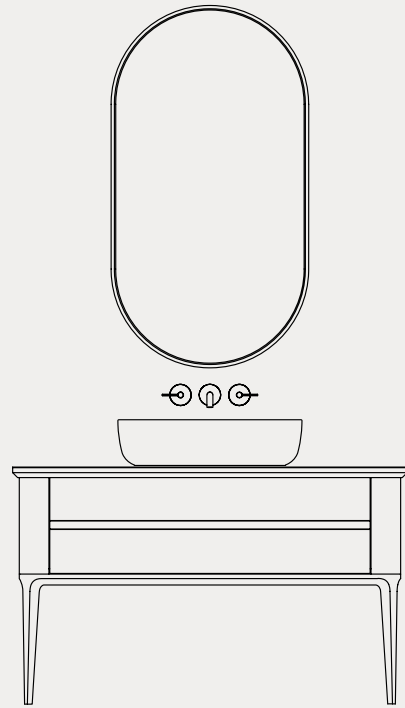

LIEM
Bathroom furniture 120 cm
Mueble 120 cm

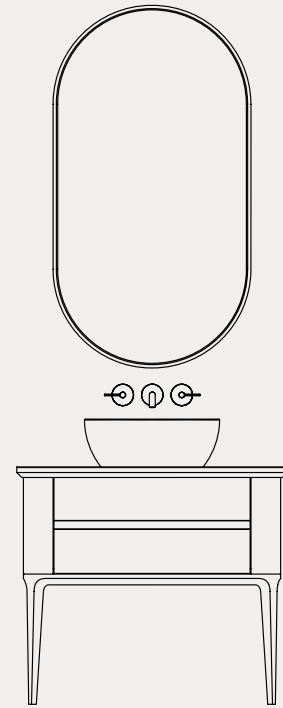

LIEM
Bathroom furniture 80 cm
Mueble 80 cm

LIEM
Mirror 185x95
Espejo 80cm

Finishes · Acabados

- Matt sand
Arena mate
- Matt grey
Gris mate

Matching basins · Lavabos compatibles

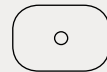

LIEM 56x39
Countertop basin
Lavabo apoyo



SLENDER 40ø
Countertop basin
Lavabo apoyo



SLENDER 41x41
Countertop basin
Lavabo apoyo

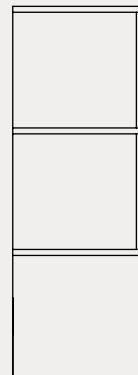

LIEM
Cabinet 100x35 cm
Cabinet 100x35 cm

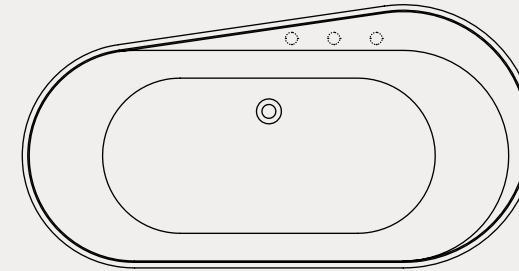

LIEM
Bathtub freestanding 185x95
Bañera exenta 185x95

Matching brassware · Griferías compatibles

PROJECT LINE
External part 3-piece bathtub installation battery.
Parte externa batería instalación bañera 3 piezas.



ROUND
100210605



ROUND
100210650



HOTELS
100165598



NK CONCEPT
100166204



URBAN
100165597



URBAN
100271603



ACRO N
100165567

PROJECT LINE
Inner body 3-piece bathtub installation battery.
Cuerpo interno batería instalación bañera 3 piezas.

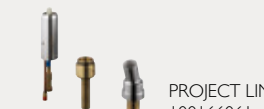

PROJECT LINE
100166061



PROJECT LINE
100271600

nk
PORCELANOSA

FINISH —
— STUDIO

Customisation. Perfection.

Unique pieces

Finish Studio is the new service which allows customised sanitary pieces to be created. An exclusive work for each project and whose result reminds us of tailoring work.

Bathtubs, basins and shower trays take on new skins, blending in with other surfaces and textures.

We are dealing with the perfect combination of innovation, a careful selection of materials and a production process in which every detail counts. The obtained result is natural colours, a pleasant touch and a unique performance regarding resistance.

Personalización. Perfección.

Piezas únicas

Finish Studio es el nuevo servicio que permite crear piezas sanitarias customizadas. Un trabajo exclusivo para cada proyecto y cuyo resultado recuerda al trabajo de sastrería.

Bañeras, lavabos y platos de ducha adquieren nuevas pieles, mimetizándose con otras superficies y texturas.

La perfecta combinación entre innovación, una cuidada selección de materiales, y un proceso de producción en el que se mima cada detalle. El resultado son colores naturales, un tacto agradable y prestaciones únicas a nivel de resistencia.

Through a highly complex customisation process, the Finish Studio service is applied to the basins of the round Slender series, which become the canvas to apply the following finishes: Botega Acero, Mosa River Grey, Botega Caliza, Gold, Copper and Titanium, weathered Black and Ferroker, by means of two types of processes: decal and paint.

The hand-painted ceramic basins are unique pieces which require high technical knowledge, as well as a sensitivity from the artisan who develops them, who not only manages to customise the piece at a visual level but also in terms of touch.

A unique and non-transferable result.

Mediante un proceso de personalización a mano de alta complejidad, el servicio Finish Studio se aplica en los lavabos de la serie Slender redondos, que se convierten en el lienzo para aplicar los acabados Botega Acero, Mosa River Grey, Botega Caliza, Oro, Cobre y Titanio, Negro desgastado y Ferroker, mediante dos tipos de proceso: calca y pintura.

Las lavabos cerámicos pintados a mano son piezas únicas que requieren un alto conocimiento técnico y una sensibilidad por parte del artesano que las desarrolla, quien consigue no solo personalizar la pieza a nivel visual sino también táctil.

Un resultado único e intransferible.



The Slate shower tray series is customised through digital printing by using cutting edge UV-LED ink with any ceramic finish which is available in the catalogue from Porcelanosa and Venis.

La serie Slate de platos de ducha se personalizan mediante impresión digital con tinta UV-LED de última tecnología con cualquier acabado cerámico disponible en el catálogo de Porcelanosa y Venis.

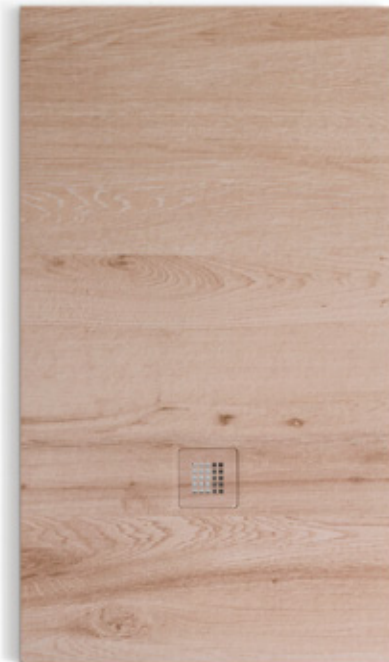
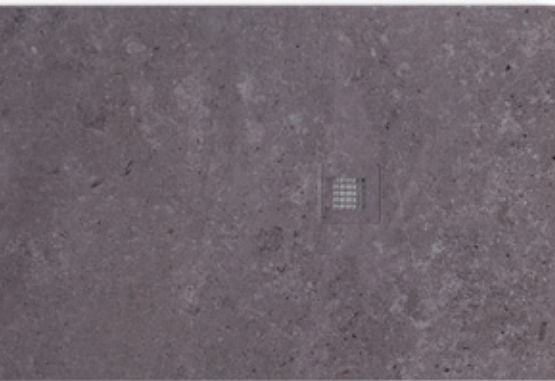

Character and personality for the bathroom.

Carácter y personalidad para el baño.



Finish Studio is applied in any colour of the RAL pattern to any bathtub model from Noken Porcelanosa Bathrooms in its panel through a handmade production process of high human value, coming with an interior in white. As well as that, it allows for the introduction of textures like slate.

Finish Studio se aplica en cualquier color de la carta RAL a cualquier modelo de bañera de Noken Porcelanosa Bathrooms en su faldón mediante un proceso de producción artesanal de alto valor humano, dejando el interior en blanco. Permite, además, la incorporación de texturas, como la pizarra.



OXO

Customisation. Cohesion. Avant-garde design

Modularity and space customisation. The bathroom design which allows production to be customised.

The Oxo series belongs to the Signature Collection, the Premium range from Noken designed exclusively by and for the company.

Personalización. Cohesión. Vanguardia

Modularidad y personalización de espacios. El diseño de baño que permite la producción a medida.

La serie Oxo pertenece a Signature Collection, la gama Premium de Noken diseñada en exclusiva por y para la firma.



The Oxo heated towel rail

With a geometric design of pure rectilinear shapes, the new Oxo heated towel rail is in line with the hydrodynamic inspiration of the series. Futuristic and structural.

In black matt and anthracite finishes, it is available in water and electric versions.

Secatoallas Oxo

Con un diseño geométrico de formas rectilíneas puras, el nuevo secatoallas Oxo sigue la estela de inspiración hidrodinámica de la serie. Futurista y estructural.

En acabados negro mate y antracita, está disponible en versiones de agua y eléctrico.

Oxo countertop 100cm
Oxo shelf
Slender countertop basin
Oxo wall mounted basin mixer
Oxo shower composition
Custom mirror

Encimera Oxo 100cm
Balda Oxo
Lavabo Slender
Monomando lavabo encastre Oxo
Espejo a medida



The Oxo modular bathroom countertops

Oxo is the cutting-edge modular collection from Noken Porcelanosa Bathrooms which allows for customised sizes. A set of pieces consisting of countertops and shelves manufactured with XTONE, which is the state-of-the-art sintered compact mineral from PORCELANOSA Grupo, and also of auxiliary furniture. XTONE enhances technical features: high impermeability and resistance to liquids, resistance to scratches and chemical elements, hygienic and easy to clean.

Encimeras de baño modulares Oxo

Oxo es la vanguardista colección modular de Noken Porcelanosa Bathrooms que permite medidas personalizadas. Un conjunto de elementos compuesto por encimeras y baldas fabricados con XTONE, el avanzado compacto mineral sinterizado de PORCELANOSA Grupo, y muebles auxiliares. XTONE hace crecer las particularidades técnicas: alta impermeabilidad y resistencia a líquidos, resistencia al rayado y a los elementos químicos, higiénico y fácil de limpiar.

Oxo countertop
Oxo shelf
Slender countertop basin
Oxo high spout single lever basin mixer
Oxo shower composition
Slate shower tray

Encimera Oxo
Balda Oxo
Lavabo Slender
Monomando lavabo caño alto Oxo
Composición de ducha Oxo
Plato de ducha Slate

The Oxo shower head in the black matt version

The new piece for the shower, the Oxo shower head, comes with the trendy black matt finish.

Rociador Oxo en versión black matt

El nuevo elemento para ducha, el rociador Oxo, se tiñe en acabado tendencia negro mate.



Customised mirrors Every small detail counts

A bathroom project is a synergy in which everything must fit. Each piece and each detail is an extension of the other. This is about harmony.

We pay attention to small decisions, and customise pieces like customised mirrors in a huge number of possibilities, as many as each designer can think of. Only then do we conceive unique rooms. Since every detail is a piece which stands for everything that one feels and believes in.

Espejos a medida El valor de los pequeños detalles

Un proyecto de baño es una sinergia en la que todo debe encajar. En el que cada elemento, cada detalle, es una extensión del otro. Una armonía.

Prestamos atención a las pequeñas decisiones, y personalizamos elementos como los espejos a medida en múltiples posibilidades, tantas como cada diseñador pueda imaginar. Solo así concebimos estancias únicas. Porque los detalles son piezas que representan todo aquello que uno siente y cree.

SLENDER Geometric simplicity

Slender is a new basin developed by Noken Porcelanosa Bathrooms with a pure design and an extra slim edge.

Its versions of rounded lines and curved edges with a minimum thickness: circular, square, rectangular and oval; enhance the purity of its planimetry and aesthetic subtlety. It offers maximum resistance and it is available in two finishes: white gloss and white matt.

SLENDER Sencillez geométrica

Slender es un nuevo lavabo desarrollado por Noken Porcelanosa Bathrooms con diseño depurado y borde extrafino.

Sus versiones de líneas redondeadas y cantos curvos con un mínimo espesor -circular, cuadrado, rectangular y ovalado- potencian la pureza de su planimetría y delicadeza estética. Máxima resistencia disponible en dos acabados: blanco brillo y blanco mate.



The Oxo taps: hydrodynamic energy

A futuristic design which finds its inspiration in aerodynamics. A unique sculptural piece for the bathroom thanks to its cutting-edge lines.

Available in three finishes: chrome, brushed titanium and black matt; the Oxo series keeps on growing through its recessed taps version. Carefully thought up to foster ecological awareness, the new Oxo taps are an ECO design, since it limits water consumption by up to a maximum of 5L per minute and it has the cold-opening system. We are dealing with a WaterForest design.

The Maximum Chrome finish provides extra resistance and long-lasting features in wet areas. Practical taps which are resistant for everyday use.

Griferías Oxo: energía hidrodinámica

Un diseño futurista inspirado en la aerodinámica. Singular pieza escultural para el baño gracias a la vanguardia de sus líneas. Disponible en tres acabados: cromo, titanio cepillado y negro mate, la serie Oxo sigue creciendo con su versión de grifería de encastre. Minuciosamente pensada para promover la conciencia ecológica, la nueva grifería Oxo es un diseño ECO, limitando el consumo de agua a un máximo de 5l/min y con apertura en frío. Un diseño WaterForest.

El acabado Maximum Chrome proporciona una resistencia extra y larga durabilidad en zonas húmedas. Una grifería práctica y resistente para el día a día.

Finishes · Acabados

- Glem Nature
- Bottega Acero

Countertop with a built-in basin Encimera con lavabo integrado

Countertops · Encimeras

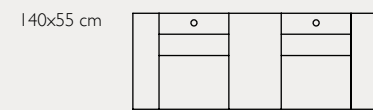
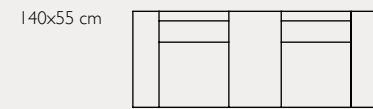
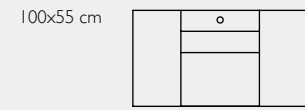
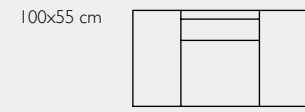

Modular bathroom countertops Encimeras de baño modulares

Countertops · Encimeras

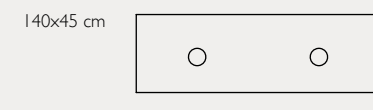
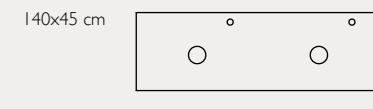
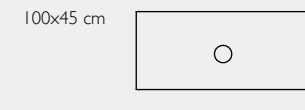

Shelves · Baldas



Drawer · Cajón

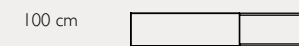

Matching basins · Lavabos compatibles



SLENDER 40ø
Countertop basin
Lavabo apoyo



FORMA 42ø
Countertop basin
Lavabo apoyo



GLOVE 39ø
Countertop basin
Lavabo apoyo

Features · Características



Chemical resistant
Resistencia química



Easy to clean
Fácil limpieza



Scratch & Impact resistant
Resistencia a golpes y arañazos



Light fastness
Estabilidad a la luz



Low water absorption
Baja absorción



Thermal resistance
Resistencia choque térmico



Hygienic & Antibacterial
Higiénico y antibacterias

Finishes · Acabados

- Chrome
Cromo
- Matt black
Negro mate
- Brushed Titanium
Titanio cepillado

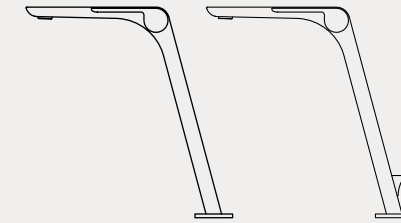

High spout single lever basin mixer
Monomando lavabo caño alto



Single lever basin mixer
Monomando lavabo



Single lever bidet mixer
Monomando bidé

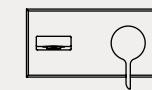

Single lever basin mixer trim kit
Monomando lavabo



Concealed thermostatic 2, 3, 4, 5 ways
Termostática encastre 2, 3, 4, 5 salidas

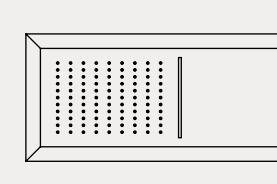

Rain + cascade shower head
Rociador lluvia + cascada

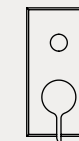

Single lever concealed bath shower mixer trim kit
Monomando encastre baño/ducha

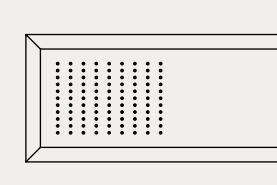

Rain shower head
Rociador lluvia



Single lever concealed shower mixer trim kit
Monomando encastre ducha

Features · Características



Variety of finishes
Variedad de acabados



Durability
Durabilidad



Ecological systems
Sistemas ecológicos



Maximum Chrome



ComfortMove



Design + Architecture
Diseño y Arquitectura



CustomSize



Process control
Control de los procesos

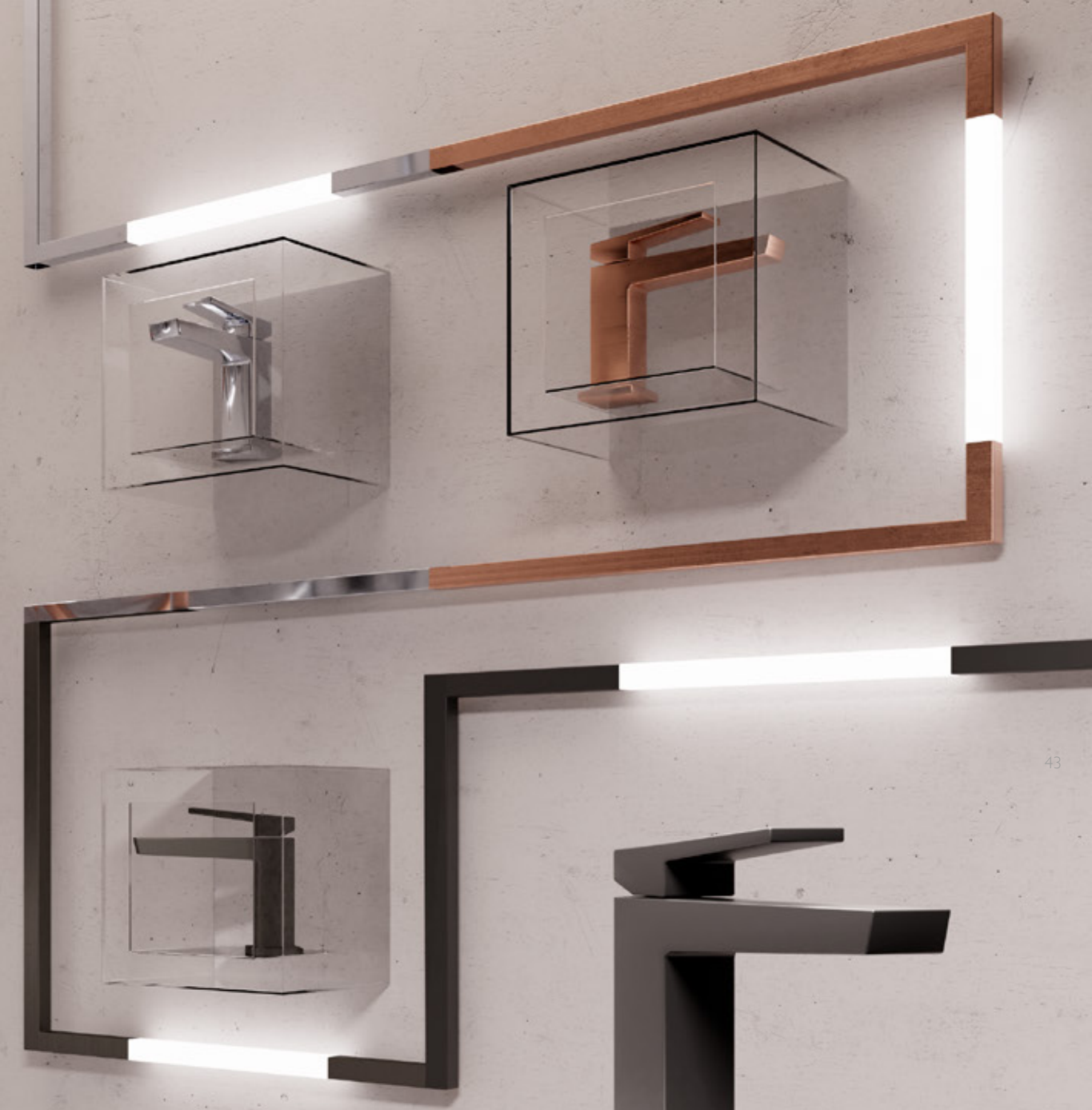

42

43

WHAT'S — — TRENDY

New shapes. New skins. New metals.

ROUND
vs.
SQUARE

SQUARE

A series of complete taps

With straight and geometric lines, and a strong character, Square taps are practical but detail oriented. Their design has been refined in their shapes providing pieces with dynamism. A combination of proportions, sizes and radii which results in taps with a unique essence.

The new Square series of bathroom taps comes with a complete collection in four finishes: chrome, black matt, polished titanium and polished copper; it includes a single lever basin mixer and bidet (with or without pop up waste), a high spout single lever, in the deck mounted versions for basins, showers and bath-showers, as well as external shower and bath-shower mixers. The collection also comes with the deck mounted thermostatic version.

SQUARE

Una serie de grifería íntegra

De líneas rectas, geométrica y marcada personalidad, Square es una grifería práctica pero detallista. Su diseño se ha depurado en sus formas aportando dinamismo a las piezas. Un juego de proporciones, medidas y radios que dan como resultado una grifería de esencia singular.

La nueva serie de grifería para baño Square se presenta como una colección completa en cuatro acabados –cromo, negro mate, titanio cepillado y cobre cepillado- que incluye monomando de lavabo y bidet (con y sin vaciador), monomando de caño alto, versiones de encastre para lavabo, ducha y baño-ducha, y mezcladores externos de ducha y baño-ducha. La colección también se presenta en versión termostática de encastre.

square

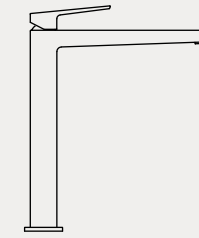

high spout single lever basin mixer
Monomando lavabo caño alto

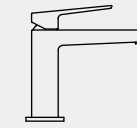

Single lever basin mixer
Monomando lavabo

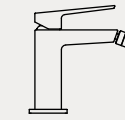

Single lever bidet mixer
Monomando bidé

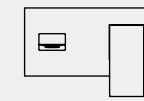

Wall mounted basin mixer
Monomando lavabo encastre

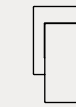

Single lever concealed shower mixer
Monomando ducha encastre



Single lever concealed bath shower mixer
Monomando baño/ducha encastre

Finishes · Acabados



Chrome
Cromo



Matt black
Negro mate



Matt titanium
Titanio cepillado



Matt cooper
Cobre cepillado

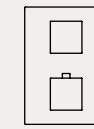

Thermostatic
Termostática encastre

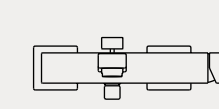

Wall mounted exposed bath shower mixer
Monomando externo baño/ducha

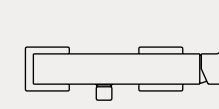

Wall mounted exposed shower mixer
Monomando externo ducha

A collection of pieces for a comprehensive bathroom design.

The built-in elements are compatible with the Project Line and Smart Box internal units, a minimalist solution which hides the tap system behind the wall. Aesthetic cleaning and greater use of space. Square is a WaterForest design, with environmentally friendly ECO technology which limits water consumption by up to 5L per minute.

Un baile de piezas para un diseño de baño integral.

Los elementos de encastre son compatibles con los cuerpos internos Project Line y Smart Box, una solución minimalista que oculta el sistema de la grifería tras la pared. Limpieza estética y mayor aprovechamiento del espacio. Square es un diseño WaterForest, con tecnología ECO respetuosa con el medio ambiente que limita el consumo de agua hasta 5 litros/minuto.

Square Mirror
Monomando lavabo encastre Square
Essence-c 120cm Wall hung basin
Essence-c Structure
Essence-c drawer

Espejo Square
Monomando lavabo encastre Square
Lavabo 120cm Essence-c
Estructura Essence-c
Cajón Essence-c



ROUND

Subtle with ECO awareness

The Round taps demonstrate how with just one bathroom element, we are able to achieve significant water savings and reduce energy consumption and CO2 emissions. It is a design included in the WaterForest concept by Noken Porcelanosa Bathrooms.

Round is an exquisite tap which saves on every last drop and it has a cold opening system. Its design incorporates a flow limiter, reducing water consumption to a maximum of 5L per minute. A saving of 60%.

Available in chrome, black matt, brushed titanium and brushed copper, as well as in its INOX version made of AISI 316 stainless steel. With versions for basins, bathtubs and showers. Vanguard design with an ecological soul.

ROUND

Sutilidad con conciencia ECO

La grifería Round ejemplifica cómo con tan solo un elemento de baño, somos capaces de conseguir un importante ahorro de agua y reducir el consumo energético y las emisiones de CO2.

Es un diseño que se incluye dentro del concepto WaterForest de Noken Porcelanosa Bathrooms.

Round es una grifería exquisita que ahorra en cada gota y cuenta con sistema de apertura en frío.

Su diseño incorpora un limitador de caudal, reduciendo el consumo de agua a un máximo de 5 litros por minuto. Un ahorro del 60%.

Disponible en acabado cromo, negro mate, titanio cepillado y cobre cepillado, así como en su versión INOX fabricada en acero inoxidable AISI 316. Con versiones para lavabo, bañera y ducha. Vanguardia con alma ecológica.



Round

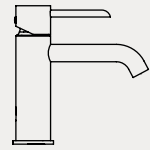

Single lever basin mixer: Without pop-up waste set. "Plus" aerator. Cold-water opening. Monomando lavabo. Sin vaciador. Aireador "plus". Apertura en frío.

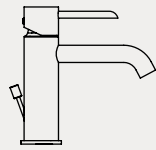

Single lever basin mixer: With pop-up waste set. "Plus" aerator. Cold-water opening. Monomando lavabo. Con vaciador. Aireador "plus". Apertura en frío.

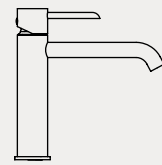

High spout single lever basin mixer: Without pop-up waste set. "Plus" aerator. Cold-water opening. Monomando lavabo caño alto. Sin vaciador. Aireador "plus". Apertura en frío.

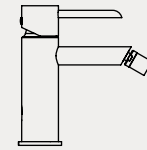

Single lever bidet mixer: Without pop-up waste set. "Plus" aerator. Cold-water opening. Monomando bidé. Sin vaciador. Aireador "plus". Apertura en frío.

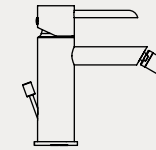

Single lever bidet mixer: With pop-up waste set. "Plus" aerator. Cold-water opening. Monomando bidé. Con vaciador. Aireador "plus". Apertura en frío.

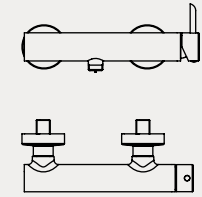

Wall mounted exposed shower mixer. Monomando externo ducha.

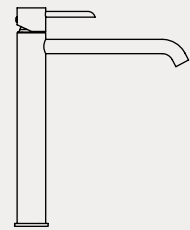

High spout single lever basin mixer: Without pop-up waste set. "Plus" aerator. Cold-water opening. Monomando lavabo caño alto. Sin vaciador. Aireador "plus". Apertura en frío.

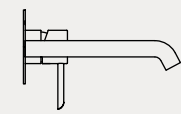

Single lever basin mixer trim kit. Without pop up waste. Parte externa monomando encastre lavabo. Sin vaciador.

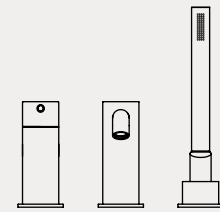

External part 3-piece bathtub installation battery. Parte externa batería instalación bañera 3 piezas.

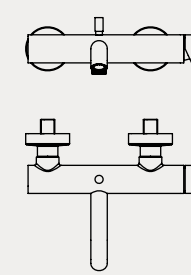

Wall mounted exposed bath shower mixer. Monomando externo baño/ducha.

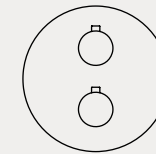

Thermostatic smart box external component. Parte externa smartbox termostático.

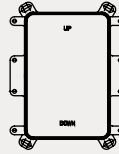

SMART BOX - Universal and quick installation for 1, 2 or 3 ways. Cuerpo empotrado de instalacion rapida universal para termostática de 1, 2 o 3 salidas.

SMART BOX - Internal thermostatic component for 3 exits. Parte interna termostática 3 salidas.

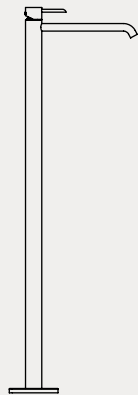

Floor mounted single lever basin mixer: Without pop-up waste set. "Plus" aerator. Cold-water opening. Monomando lavabo instalación a pavimento.

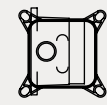

SMART BOX BATH - Built-in body with universal quick installation for floor taps. SMART BOX BATH - Cuerpo empotrado de instalación rápida universal para griferías a pavimento.

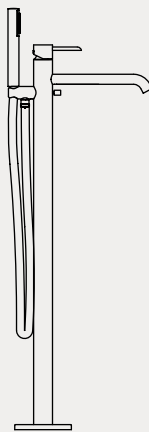

Floor mounted single lever bath shower mixer. Includes hand shower and 150cm shower hose. Automatic diverter. "Plus" aerator. Monomando baño/ducha instalación a pavimento con flexible de 150cm y teleducha. Inversor automático y aireador "plus".

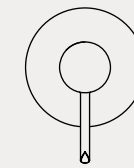

Single lever concealed shower mixer trim kit. Parte externa monomando encastre ducha.

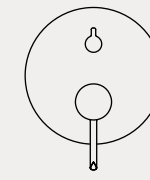

Single lever concealed bath shower mixer trim kit. Parte externa monomando encastre baño/ducha.

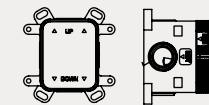

SMART BOX - Universal and quick installation for 1 way. Cuerpo empotrado de instalacion rapida universal para mezclador de 1 salida.

SMART BOX - Internal component for built-in mixer 100124166. Partes internas para cuerpo empotrado mezclador 100124166.

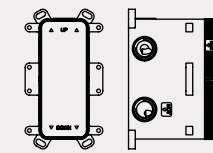

SMART BOX - Universal and quick installation for 2 or 3 way. Cuerpo empotrado de instalacion rapida universal para mezclador de 2 o 3 salidas.

SMART BOX - Internal component for built-in mixer 100124167. Partes internas para cuerpo empotrado mezclador 100124167.

Finishes · Acabados



Chrome
Cromo



Matt black
Negro mate



Matt titanium
Titanio cepillado



Matt cooper
Cobre cepillado

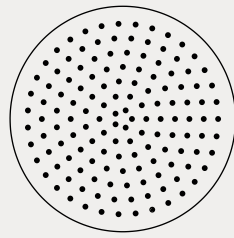

Shower head 30cm
Rociador 30cm



Shower head 10cm
Rociador 10cm



shower head arm, ceiling
connection
Brazo rociador a techo

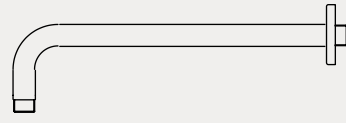

Shower head arm, wall connection
Brazo rociador a pared



Handshowers
Teleducha



Shower outlet elbow
Toma de agua

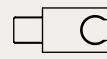

Wall bracket
Soporte teleducha

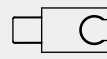

Wall bracket with outlet elbow
Soporte teleducha con toma de
agua



handshower bar with bracket
Barra de ducha

Finishes · Acabados



Inox
Inox



COLOR is the melody of light
EL COLOR es la melodía de la luz



INK CERAMIC —
— COLORS

Noken Ceramic, the high-end ceramic range, comes in colour: White gloss, white matt, black matt, brown, grey and sand; in floor mounted basins, toilets and basins. An ultra-compact ceramic which guarantees high strength in the bathroom equipment due to its firing at 1250°. A material innovation and a chemical formulation like NK Protect, achieve a hypoallergenic material, pore-free vitrified, scratch resistant and unalterable against any thermal shock. High quality that takes sanitary ware ceramic to a higher level. Eternally perfect toilets, which stay as good as new.

Noken Ceramic, la alta gama cerámica, llega en color: Blanco brillo, blanco mate, negro mate, marrón, gris y arena, en lavabos a suelo, inodoros y lavabos. Una cerámica ultra-compacta que garantiza una alta resistencia en el equipamiento de baño gracias a su cocción a 1250°. Innovación matérica y una formulación química como NK Protect, consiguen un material hipoalergénico, vitrificado sin poro, resistente al rayado e inalterable al choque térmico. Alta calidad para elevar la cerámica sanitaria a un nivel superior. Sanitarios eternamente perfectos, bellos como el primer día.





56

57

LIGNAGE —

LIGNAGE

Designed by Ramón Esteve

#UpcomingTradition

Ramón Esteve's gem. The past and the future from Noken Porcelanosa Bathrooms.

La joya de Ramón Esteve. El pasado y el futuro de Noken Porcelanosa Bathrooms.

Lignage, the signature taps designed by Ramón Esteve.

Best Design at the IF Design Awards 2019.

Lignage is Noken's legacy for future design. A pure-lined design with a classic-renewed essence which reminds us of classic taps but with a modern-day look.



Lignage, la grifería de autor creada por Ramón Esteve.

Mejor Diseño de los IF Design Awards 2019.

Lignage es el legado de Noken al diseño del mañana. Un diseño de líneas depuradas y esencia clásico-renovada recuerda a las griferías clásicas pero con una estética totalmente actual.

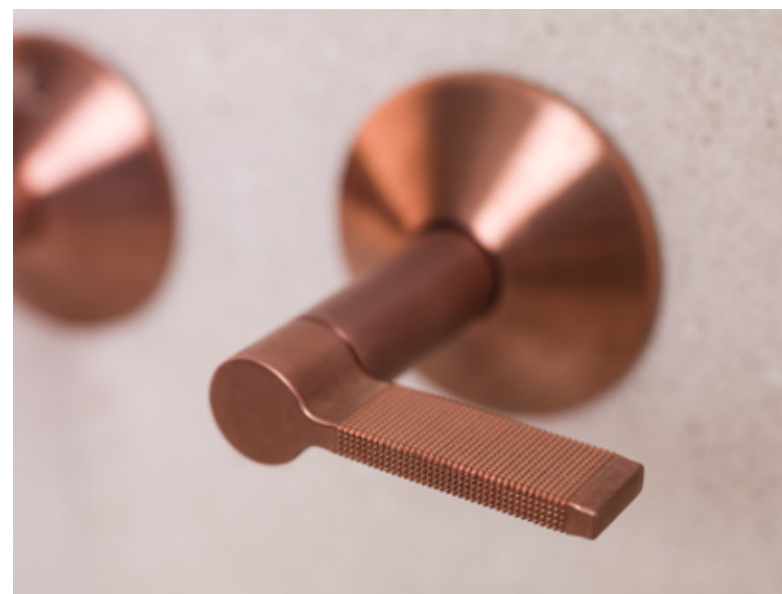

Lignage. A trip in time

Lignage is Noken's legacy for the design of tomorrow. A design of refined lines and classic-renewed essence reminds of traditional taps but with a totally modern-day aesthetic.

Bathroom taps with the signature seal. Created by Ramón Esteve exclusively, his character is expressed in each of the formats. Single lever, three-piece battery and three built-in piece battery; as well as in its different finishes: brushed copper, gold gloss and chrome. Different versions of the same piece.

Its versatility is completed with another of its hallmarks: its functional and original handle, smooth or textured, a more classic version of the taps.

Lignage. Un viaje en el tiempo

Lignage es el legado de Noken al diseño del mañana. Un diseño de líneas depuradas y esencia clásico-renovada recuerda a las griferías tradicionales pero con una estética totalmente actual.

Grifería de baño con sello de autor. Creada por Ramón Esteve en exclusiva, su carácter se expresa en cada una de sus formatos. Monomando, batería tres piezas y batería tres piezas de encastre; así como en sus distintos acabados: cobre cepillado, oro brillo y cromo. Diversas versiones de una misma pieza.

Su versatilidad se completa con otra de sus señas de identidad: su funcional y original maneta, lisa o con texturas, una versión más clásica de la grifería.



LIGNAGE

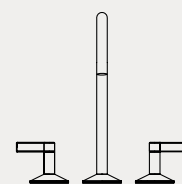

3 hole basin mixer
Batería lavabo 3 piezas

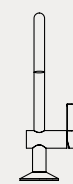

Single lever basin mixer
Monomando lavabo



Wall mounted basin mixer
Batería lavabo 3 piezas
encastre

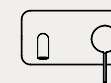

Single lever basin mixer
trim kit
Parte externa monomando
encastre lavabo



Single lever bidet mixer
Monomando bidé



2 ways concealed diverter
valve
Inversor encastre pared 2
salidas



3 ways concealed diverter
valve
Inversor encastre pared 3
salidas



Wall bracket
Soporte fijo teleducha



Shower outlet elbow
Toma de agua



Wall bracket with outlet
elbow
Soporte teleducha pared con
toma de agua



Rain shower head with arm
Rociador función lluvia con
brazo



Wall mounted stop valve
Llave de paso encastre ducha

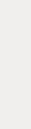

Single function handshower
Teleducha 1 posición

SMARTBOX



Single lever concealed shower
mixer trim kit
Parte externa monomando
encastre ducha

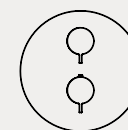

Thermostatic smart box
external component
Parte externa smartbox
termostático

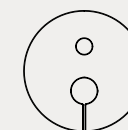

Single lever concealed bath
shower mixer trim kit
Parte externa monomando
encastre baño ducha

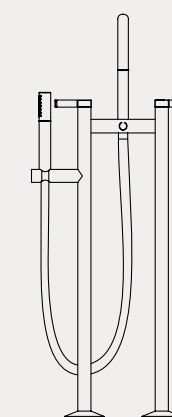

Floor mounted monoblock bath shower mixer
Monoblock baño/ducha instalación a pavimento

Finishes · Acabados



Chrome
Cromo



Gold
Oro



Brushed copper
Cobre cepillado

TOUCH— — FEEL



TOUCH&FEEL

Touch and feel. As simple as that.

Touch & Feel is the simple and intuitive shower system which activates the sought-after experience by soft pushing, allowing several functions simultaneously. The series grows with two shower columns whose designs fit perfectly with any bathroom style, in a square and round version. With a simple touch, we will activate the sought-after water outlet and with a controlled flow. An intuitive and safe shower, since it is equipped with a safety system so that the temperature does not exceed 38°C and, in case of wanting to raise this temperature, it will be necessary to press a button to reach a maximum whose limit is 45°C. The Touch & Feel shower column is a WaterForest product, environmentally friendly by contributing to water savings, with limited water consumption at 14L per minute for the shower head and 10L per minute for the hand shower. As well as that, there is energy efficiency, since it quickly reaches the sought-after temperature, keeping it stable even if there are pressure variations.



Touch & feel

TOUCH & FEEL ROUND

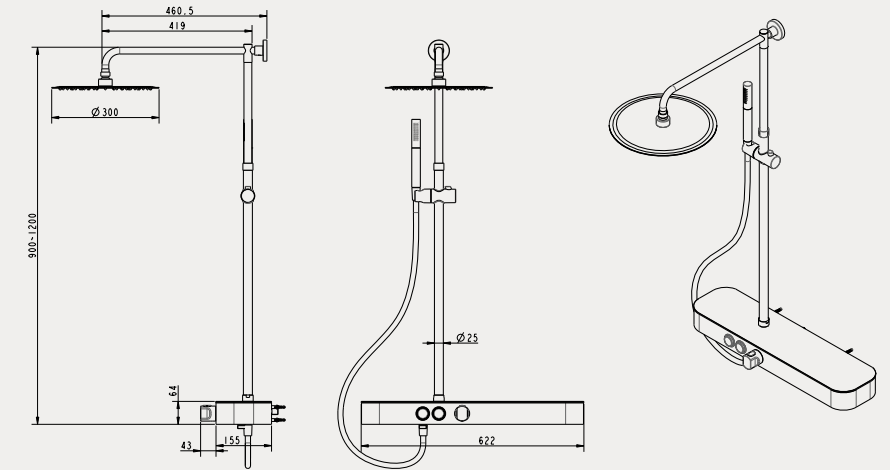

TOUCH & FEEL SQUARE

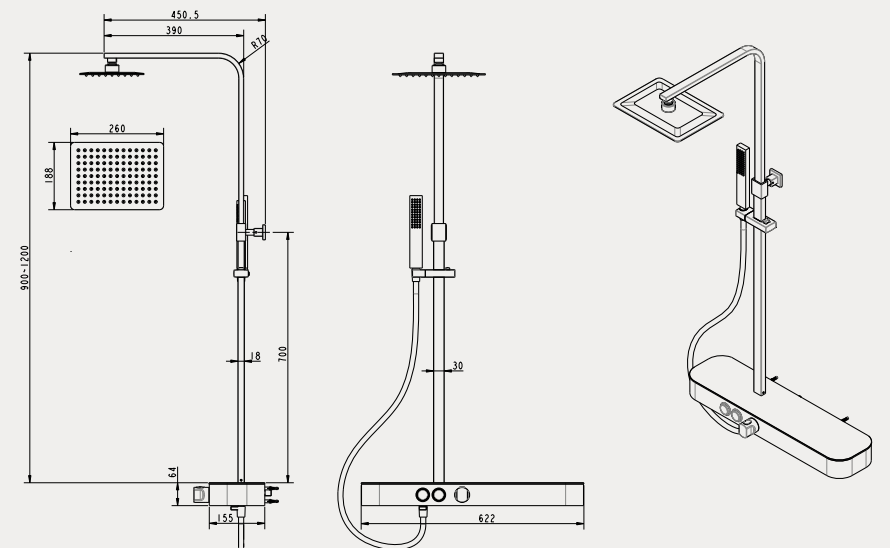

Shower column
Columna de ducha



TOUCH&FEEL

Tocar y sentir. Así de sencillo.

Touch&Feel es el sistema de ducha sencillo e intuitivo que activa la experiencia deseada mediante una suave pulsación, permitiendo varias funciones simultáneamente. La serie crece con dos columnas de ducha cuyos diseños se integran perfectamente en cualquier estilo de baño, en versión cuadrada y redonda. Con un simple toque activaremos la salida deseada y con un caudal controlado. Una ducha intuitiva y segura, ya que viene equipada con un sistema de seguridad para que la temperatura no sobrepase los 38°C y, en caso de querer subir esta temperatura, será necesario pulsar un botón para llegar a un máximo cuyo límite son los 45°C. La columna de ducha Touch&Feel es un producto WaterForest, respetuoso con el medio ambiente al contribuir a un ahorro de agua -con un consumo de agua limitado a 14 l/min. para el rociador y 10 l/min. para la teleducha- y a la eficiencia energética, ya que alcanza rápidamente la temperatura deseada, manteniéndola estable aunque haya variaciones de presión.



66

67

UNDER —
— WATER

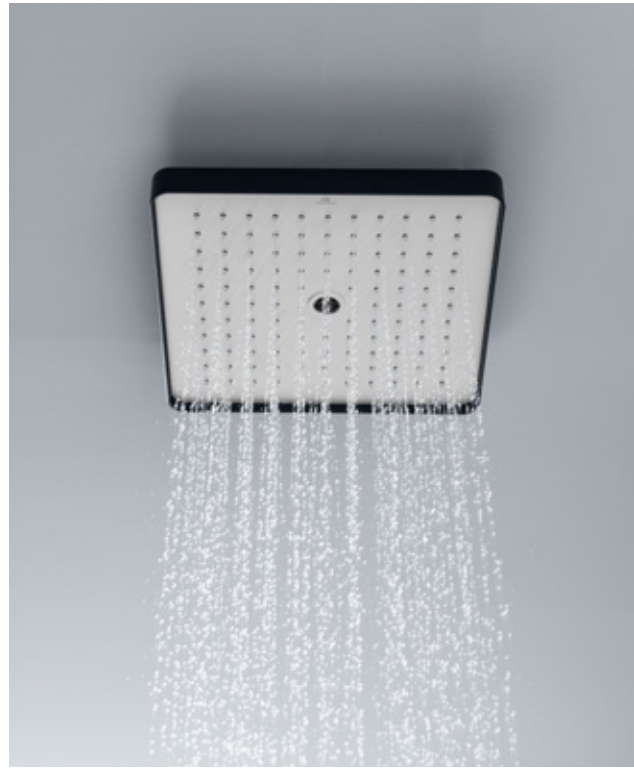

DOT

The unit shower

DOT introduces the unit system in the shower: Shower heads which allow infinite combinations in 30cm and 15cm square or round sizes. Colours: black box with a white front or white box with a black front. Functions: rain, central jet, sprayer or cascade, combinable with chromotherapy.

A compact and combinable design which fits in all types of bathrooms. Ideal for a SPA, where you can design walk through areas with many water functions and choose from the different colours of chromotherapy.

DOT

La ducha modular

DOT introduce el sistema modular en la ducha. Rociadores que permiten infinidad de combinaciones en formatos -cuadrado o redondo, en 30 y 15cm-, colores -caja negra con frontal blanco o caja blanca con frontal negro- y funcionalidades -lluvia, chorro central, vaporizador o cascada, combinables con cromoterapia-

Una diseño compacto y combinable entre sí que encaja en todo tipo de baños. Ideales para SPA, donde se podrán diseñar pasillos con infinidad de funciones de agua y jugar con los distintos colores de cromoterapia.

307 x 307 mm

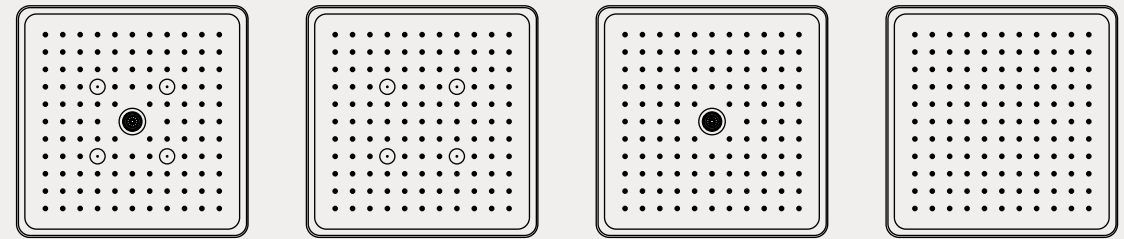

ø 307 mm

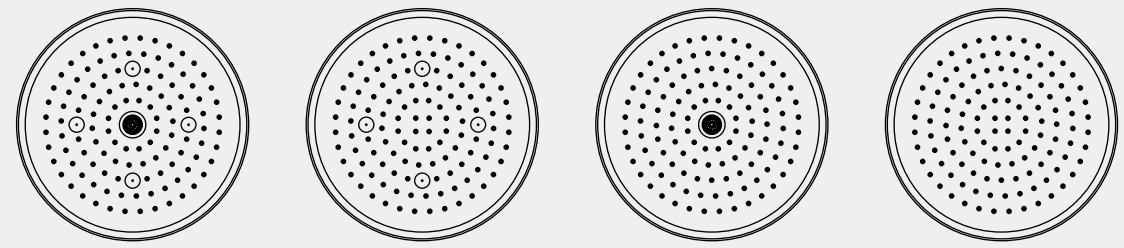

157x157 mm

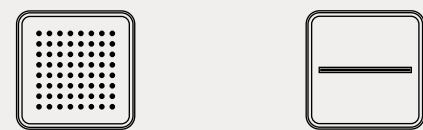

ø 157 mm

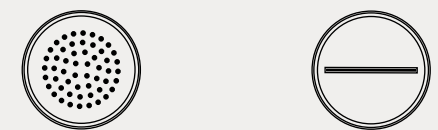

DOT is included under the WaterForest sustainable concept with limited maximum flow:

- Nebuliser at 5L per minute
- Rain at 10L per minute
- Cascade at 12L per minute
- Central jet at 12L per minute

* Available in version with and without light.
Disponible en versión con y sin luz.

DOT se engloba bajo el concepto sostenible WaterForest con caudal máximo limitado:

- Nebulizador a 5 l/min
- Lluvia a 10 l/min
- Cascada a 12 l/min
- Chorro central a 12 l/min

The new Wellness built-in shower heads have two functions: rain and cascade; they can be combined with chromotherapy functions, all of them can be activated by remote control. A pleasant experience where we will combine the power of water with a wide range of colours with which the client can select the ideal colour or program to enjoy a unique moment every day.

Available in two formats: 40cm round and 40cm x 40cm square; the Wellness Rondo and Square sprinklers are two built-in models which reduce the equipment in these spaces to the minimum.

Los nuevos rociadores Wellness de encastre incorporan dos funciones -lluvia y cascada-, y pueden combinarse con funciones de cromoterapia, todas ellas accionables por medio de un mando. Una experiencia placentera donde combinaremos el poder del agua con una amplia gama de colores con la que el cliente podrá seleccionar el color o programa ideal para vivir un momento único cada día.

Disponibles en dos formatos -redondo de 40 cm y cuadrado de 40x40 cm- los rociadores Wellness Rondo y Square son dos modelos encastrados que reducen el equipamiento en estos espacios a la mínima expresión.

WATERFALL



RONDO

ø 400 mm

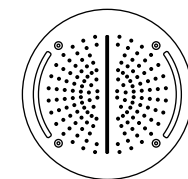

Rain
Lluvia



Cascade
Cascada



Chromotherapy
Cromoteràpia

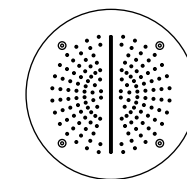

Rain
Lluvia



Cascade
Cascada



SQUARE

400x400 mm

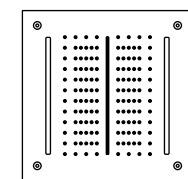

Rain
Lluvia



Cascade
Cascada



Chromotherapy
Cromoteràpia

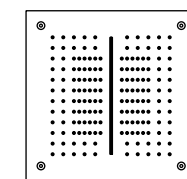

Rain
Lluvia



Cascade
Cascada









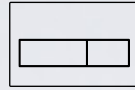

72

73

PRESS —
— TO COLOR









Tono



-  Brushed stainless steel
Inox cepillado
-  Gloss copper
Cobre brillo
-  Brushed copper
Cobre cepillado
-  Gloss titanium
Titanio brillo
-  Matt titanium
Titanio cepillado
-  Gloss gold
Oro brillo
-  Brushed gold
Oro cepillado

Rondo



-  Chrome
Cromo
-  White
Blanco
-  Gloss copper
Cobre brillo
-  Brushed copper
Cobre cepillado
-  Gloss titanium
Titanio brillo
-  Brushed titanium
Titanio cepillado
-  Gloss gold
Oro brillo
-  Brushed gold
Oro cepillado

Forma



-  Chrome
Cromo
-  Gloss gold
Oro brillo
-  Gloss copper
Cobre brillo
-  Gloss titanium
Titanio brillo

Oval

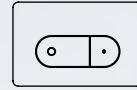

-  Chrome
Cromo
-  Black
Negro
-  White
Blanco

Push to the boundaries

We take design to its limits. To the finest detail.

The new special finishes in toilet flush buttons manage to integrate each element of the bathroom into the set.

Push to the boundaries

Elevamos el diseño hasta sus límites. Hasta los mínimos detalles.

Los nuevos acabados especiales en pulsadores de inodoros consiguen integrar cada elemento del baño en el conjunto.

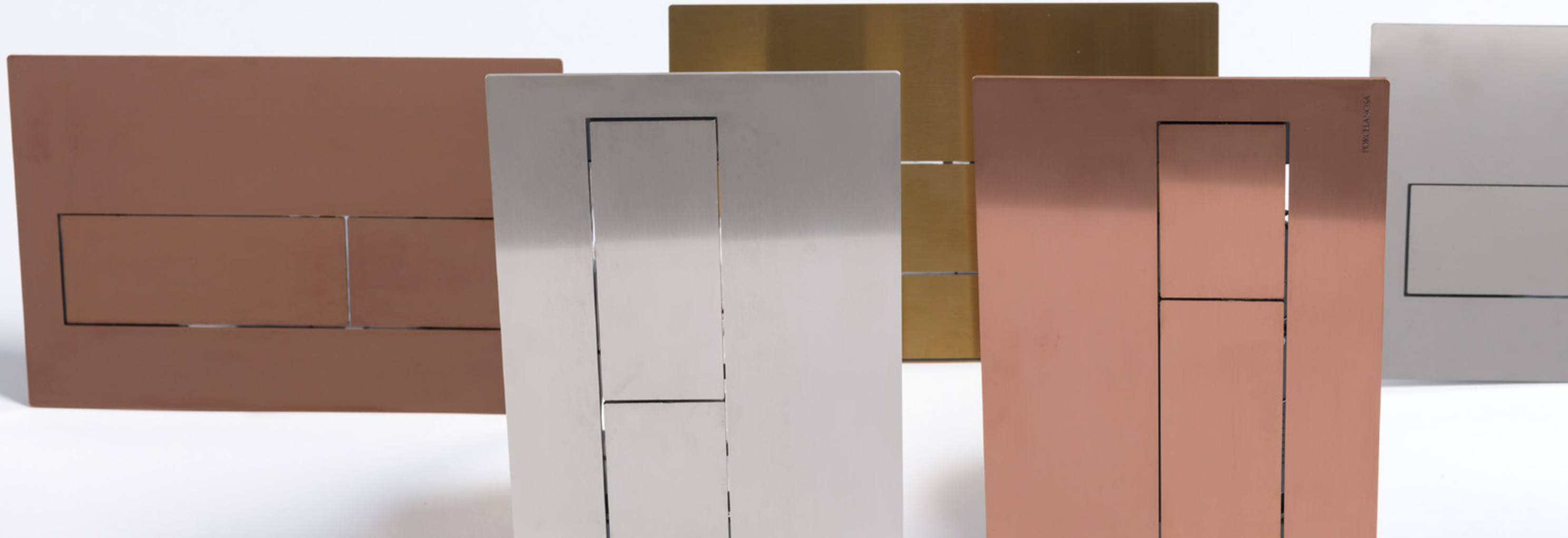

SMART — TOILET



Smart the basics. Smart your dailies.

Noken Smart Toilet

Pásate al concepto Smart, también en los básicos de tu día a día. Noken Smart Toilet

A new evolution of the smart toilet which synchronizes aesthetics and technology. Minimalist and timeless. A return to the origin.

A new way of understanding daily hygiene based on water purity, in which people take control.

Una nueva evolución del inodoro inteligente que sincroniza estética y tecnología. Minimalista y atemporal. Un regreso al origen.

Un nuevo modo de entender la higiene diaria basada en la pureza del agua, en la que el usuario toma el control.



Adjustable temperature and water pressure
Temperatura y fuerza del agua ajustable



Drying function, with adjustable temperature
Función de secado, con temperatura regulable



Odor extraction system
Sistema de extracción de olores



Lighting for night use
Iluminación para uso nocturno



Sistema soft-close de cierre ralentizado
Sistema soft-close de cierre ralentizado



Rimless NK-Clean 6 / 3L flush system
Sistema de descarga Rimless NK-Clean de 6/3l



Remote control or function control from the seat itself
Mando a distancia o control de funciones desde el propio asiento



Self-control technology with three water functions, before and after washing and a massage option, as well as default position settings for each user
Tecnología auto-control con tres funciones de agua -lavado posterior, anterior y opción de masaje-, y configuración de posiciones predeterminadas para cada usuario





LOUNGE —



New LOUNGE

With Rimless NK-Clean efficient cleaning system

Inspired by the design of the series created by Simone Micheli, Lounge is renewed with a new version of Rimless NK-Clean wall-hung toilet and bidet. Exquisite pieces for which time stands still, always elegant, always current.

The Rimless NK-Clean toilet cleaning system eliminates the hoop in its design and allows water to be circulated powerfully inside the toilet in a 360° course.

- Extreme hygiene
- Easy cleaning of the piece
- The water is distributed with greater pressure in a 360° course cleaning its entire surface
- No splashes

Manufactured in Noken Ceramic™ high-end sanitary ceramic, a seat with slow-closing soft-close and removable take-off system, the new Lounge toilet is compatible with Smart Line built-in double flush ECO of 4.5 / 3 litre cisterns which contributes to saving of up to 56% water and it belongs to the WaterForest range.

New LOUNGE

Con sistema de limpieza eficiente Rimless NK-Clean

Inspirados en el diseño de la serie creada por Simone Micheli, Lounge se renueva con una nueva versión de inodoro suspendido Rimless NK-Clean y bidé. Piezas exquisitas para las que no pasa el tiempo, siempre elegantes, siempre actuales.

El sistema Rimless NK-Clean de limpieza para inodoros elimina el aro en su diseño y permite que el agua circule con fuerza por el interior de la taza en un recorrido 360°.

- Máxima higiene
- Fácil limpieza de la pieza
- El agua se distribuye con mayor fuerza en un recorrido 360° limpiando toda su superficie
- Sin salpicaduras

Fabricado en alta cerámica sanitaria Noken Ceramic®, asiento con cierre ralentizado soft-close y sistema desmontable take-off, el nuevo inodoro Lounge es compatible con cisternas empotradas Smart Line de doble descarga ECO de 4,5/3 litros que contribuye al ahorro de hasta un 56% de agua y pertenece a la gama WaterForest.

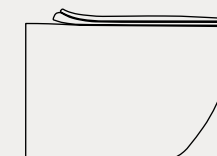

noken
nkclean™

noken
ceramic™

4,5/3L

SOFT
CLOSE

10
YEARS
WARRANTY

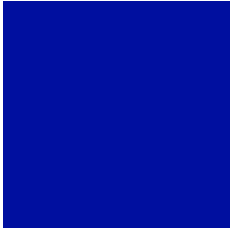

See you soon!!
Nos vemos pronto!!

noken
PORCELANOSA BATHROOMS

NOKEN DESIGN, S.A. CV-20 km. 2
12540 - Vila-real - Castellón - Spain

Tel: +34 964 50 64 50
Fax: +34 964 50 67 93
e-mail: noken@noken.com
www.noken.com



BY APPOINTMENT TO
H.R.H. THE PRINCE OF WALES
MANUFACTURER AND DISTRIBUTOR
OF CERAMIC TILES AND BUILDING PRODUCTS
PORCELANOSA GROUP LIMITED
PORCELANOSA Grupo



NOKEN DESIGN, S.A. The contents of this catalogue are protected by virtue of the Spanish Intellectual Property Act, Royal Legislative Decree 1/1996. The partial or total reproduction of this catalogue, without the express authorisation of NOKEN DESIGN is punishable under the Spanish Criminal Code. Reserves the right to cancel and/ or change models or accessories without prior notice or replacement. The settings shown in this catalogue are design proposals for advertising purposes. In real situations in which the tiles are laid, we recommend to use as a guide for the installation, the technical specifications available on the Noken GENERAL RATE.

NOKEN DESIGN, S.A. El contenido de este catálogo está protegido por la Ley de Propiedad Intelectual, Real Decreto Legislativo 1/1996. Cualquier reproducción del mismo, en parte o en su totalidad, sin autorización expresa de Noken Design, S.A. puede ser sancionada conforme el Código Penal. Se reserva el derecho legal de anular y/o aportar posibles modificaciones a sus productos y accesorios sin previo aviso ni sustitución. Los ambientes que se muestran en este catálogo son sugerencias decorativas de carácter publicitario, debiéndose utilizar como guía para la instalación, las fichas técnicas que se encuentran en el TARIFA GENERAL editado por Noken.

Graphic Design _ Marketing department by Noken

Art Direction _ Marketing department by Noken

Photography _ Marketing department by Noken

Publisher _ Noken Design, S.A.

Printed by _ Gráficas Alcoy

January _ 2020



BY APPOINTMENT TO
H.R.H. THE PRINCE OF WALES
MANUFACTURER AND DISTRIBUTOR
OF CERAMIC TILES AND BUILDING PRODUCTS
PORCELANOSA GROUP LIMITED

PORCELANOSA Grupo